Operating Instructions



ProLine
pH meter B210



Contents

1.	Introduction	3
2.	Safety measures	3
	Measures for your protection	3
	Measures for operational safety	3
3.	Description of the instrument	4
	3.1 Display	4
	3.2 Keypad	5
4.	Installation	6
5.	Sample Measurement	7
	5.1 pH measurement	7
	5.2 mV measurement	7
	5.3 Settings	7
	5.3.1 ATC	7
	5.3.2 MTC	7
	5.3.3 Data output	7
6.	Calibration	8
	6.1 Settings	8
	6.2 Select a fixed buffer group	8
	6.3 Set a user-defined buffer group	8
	6.4 Calibration	9
	6.4.1 1-Point calibration	9
	6.4.2 2-Point calibration	9
	6.4.3 3-Point calibration	9
7.	Self-Diagnosis	10
8.	Optional battery operation	10
9.	Error messages	11
10.	Maintenance	12
	10.1 Meter maintenance	12
	10.2 Electrode maintenance	12
	10.3 Disposal	12
11.	Accessories	13
12.	Specifications	14
13.	Quick Guide	15
14.	Buffer sets	16

1. Introduction

ProLine – an instrument which offers far more than simple pH measurement, without breaking your budget. An instrument with so many advantages:

- ProLine saves you time. The user interface is designed in such a logical way that you will no longer need to consult your user manual.
- ProLine can be battery operated. Thanks to this option you can now easily move your instrument from one working area to another even when no power supply is available.
- ProLine has added value. Our Service Option allows for regular Equipment Qualification which will improve the reliability and accuracy of your instrument.

2. Safety measures

Measures for your protection



- Never work in an environment subject to explosion hazards! The housing of the instrument is not gas tight (explosion hazard due to spark formation, corrosion caused by the ingress of gases).



- When using chemicals and solvents, comply with the instructions of the producer and the general lab safety rules!

Measures for operational safety



- Have the instrument serviced only by QiS Service!
- Always wipe off splashed liquids immediately! The instrument is not waterproof.
- Use batteries of the specified type only. Otherwise, proper operation cannot be guaranteed.
- Exclude the following environmental influences:
 - powerful vibrations,
 - direct sunlight,
 - atmospheric humidity greater than 80%,
 - corrosive gases present,
 - temperatures below 5 °C and above 40 °C,
 - powerful electric or magnetic fields!

3. Description of the instrument

3.1 Display

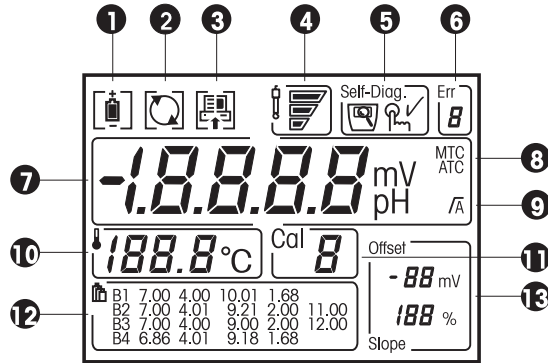

1 Battery status

2 Auto-off override during battery operation

3 Data transfer to PC/Printer

4 Electrode condition



slope: 95-105 %
offset: ± (0-15) mV
Electrode is in
good condition



slope: 90-94 %
offset: ± (15-35) mV
Electrode needs
cleaning



slope: 85-89 %
offset: ± (>35) mV
Electrode is faulty

5 Meter self-diagnosis



Self-diagnosis
indicator



Indication to
press key



Self-diagnosis
passed

6 Error index

7 pH/mV-reading

8 Auto/Manual Temperature compensation

9 Endpoint stability/autom endpoint

Endpoint stability

A Auto endpoint

10 Temperature









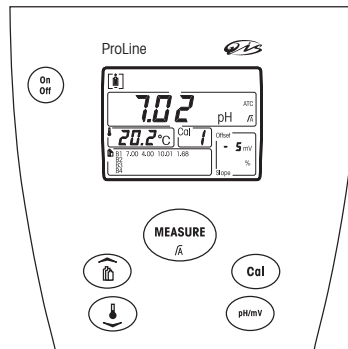



11 Calibration point

12 Buffer groups

13 Electrode offset and slope

3.2 Keypad



	Press & release 	Press & hold for 2 seconds 	
	Meter on/off	Auto-off override during battery operation	
	- Start or endpoint measurement - Return to measurement mode - Store entered value	Turn auto endpoint on/off	
	- Start calibration - Confirm buffer group selected	Displaying the buffers used for the calibration	
	Switch between pH- and mV measurement mode	Data transfer to PC or printer	
	- Select calibration buffer groups - Increase value during setting		
	- Set MTC-temperature - Decrease value during setting		
	Start meter self-diagnosis Self-Diag.		

Installation

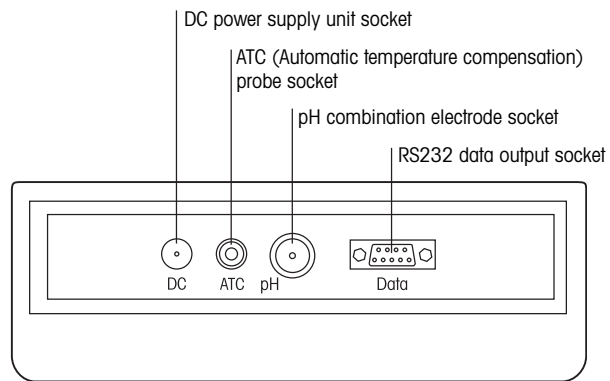



4. Installation

1. Unpack the meter, power adapter, electrode, electrode arm and other accessories. Keep the calibration certificate in a safe place.
2. Make sure the power adapter matches your local power supply. If not, please contact your vendor.
3. Disconnect the shorting clip from the pH socket.
4. Connect the electrode. If you are using an electrode with a built-in temperature probe, connect the other lead to the ATC socket.
5. If you are using a separate temperature probe, connect it to the ATC socket.
6. Connect the power supply unit to the DC socket.

5. Sample Measurement

5.1 pH measurement

Place electrode in sample and press  to start the measurement: the decimal point flashes. The display shows the pH of the sample. The automatic endpoint **A** is the meter's default setting. When the sensor output has stabilized, the display freezes automatically, and \sqrt{A} appears. The automatic endpoint algorithm is 0.1 mV per 5 seconds.

By pressing and holding the  key, you can switch between auto and manual endpoint mode. To manually endpoint a measurement, press , the display freezes and \sqrt{A} appears.

5.2 mV measurement

To perform a mV measurement, follow the same procedure as for pH measurement. To see the mV value during pH measurement, simply press .





5.3 Settings

5.3.1 ATC

For better accuracy, we recommend the use of either a built-in or a separate temperature probe. When a temperature probe is used, the symbol **ATC** and the sample temperature are displayed.

5.3.2 MTC

When the meter does not detect a temperature probe, it automatically switches to manual temperature compensation mode, and **MTC** appears.

To set the MTC temperature, press  to start, use  and  to increase or decrease the value to the temperature of your sample. Press the  key to confirm your setting. The default setting is 25 °C.

5.3.3 Data output

If a PC or printer is connected, every endpointed reading is sent to PC or printed through the RS232 interface.

By pressing and holding the  key  appears. The meter sends out a reading every second until it has endpointed.

6. Calibration

6.1 Settings

The ProLine pH meter allows you to perform 1-, 2- and 3-point calibrations. If you select your calibration buffer group from the 4 fixed groups defined in the meter, the buffers are automatically recognized during calibration (auto buffer recognition).



The 4 fixed buffer groups are:

B1: (25 °C)	7.00	4.00	10.01	1.68	
B2: (25 °C)	7.00	4.01	9.21	2.00	11.00
B3: (20 °C)	7.00	4.00	9.00	2.00	12.00
B4: (25 °C)	6.86	4.01	9.18	1.68	





You can also follow the buffer setting procedure below to define your own buffer group, but in this case the auto buffer recognition will not work during calibration.



6.2 Select a fixed buffer group

Press the  key, the current buffer group starts blinking. If the current setting is the user-defined group, the blank frame blinks.

Use the  or  key to select other groups in the upper or lower position. When the desired buffer group blinks, press  to confirm your selection.

6.3 Set a user-defined buffer group

In step 6.2, when the blank frame blinks, press  to start setting. The meter displays your current temperature value setting and the dot and frame blink (default temperature is 25 °C). Use  or  key to change the value. Press  to store the value and continue.

After setting the temperature value, the meter displays the current setting of the first calibration buffer (default value 4.00). Use  or  key to change the value. Press  to store the value and continue.

After setting the first calibration buffer, press  to start setting the next point.

The procedure is the same as for the 1st point. You can set up to 3 user-defined calibration buffers. When you have completed your settings, press  to exit.

Note

When using a user-defined buffer group in the calibration, the screen will display the buffer value you set. Make sure that you are using the correct buffer. You should also keep the buffer temperature at the set value. When a temperature probe is used, if the temperature measured differs by more than 1 degree from the set value, Err 5 appears.

6.4 Calibration

6.4.1 1-Point calibration

Place the electrode in a calibration buffer and press .

The ProLine pH meter automatically endpoints when calibrating. To manually endpoint, press . The meter displays and freezes the relevant buffer value, and shows the electrode offset.

To return to sample measurement, press .

6.4.2 2-Point calibration

Step 1 Perform the first point calibration as described in "1-Point calibration".

Step 2 Use distilled water to rinse the electrode.

Step 3 Place the electrode in the next calibration buffer and press .

The ProLine pH meter automatically endpoints when calibrating. To manually endpoint, press . The meter displays and freezes the relevant buffer value, updates the electrode offset and shows its slope.

To return to sample measurement, press .

6.4.3 3-Point calibration

Perform the same steps as in the "2-Point calibration", then repeat steps 2 and 3 for the third point calibration.



Note

The use of a temperature probe or electrode with a built-in temperature probe is recommended. If you use the MTC mode, you should keep all buffer and sample solutions at the same set temperature.

To ensure the most accurate pH readings, you should perform a calibration regularly.









By pressing and holding the  key, the number and type of buffers used for the calibration are displayed. The buffer values appear in alternating order.

7. Self-Diagnosis

Press and hold  and  simultaneously until the meter self-diagnosis icon  appears.

The meter displays the full screen first, then each icon blinks one after the other. The final step is to check that the keys function. This requires the user's cooperation.

When the icon  blinks, depending on the flashing content, press the corresponding key within 5 seconds.



- When  flashes, press the  key;
- When  flashes, press the  key;
- When  flashes, press the pH/mV key;
- When  flashes, press the  key;
- When  °C flashes, press the  key.

When self-diagnosis is completed, a  icon appears. If the self-diagnosis fails, turn to "9. Error Messages" in these operating instructions for the proper action(s).

8. Optional battery operation

The ProLine pH meter offers optional battery operation. Install 4 AA batteries in the rear of the meter. If the power adapter is disconnected, the meter is operated by battery and the  icon appears.

When the batteries lose power, the meter displays .

During battery operation, the meter has an auto-off function - if no key is pressed during the next 10 minutes, the meter will automatically switch off to save battery power. To override the auto-off function, press and hold  key for 2 seconds until  appears.

9. Error messages

Error 1 - Offset out of range

Make sure you have the correct buffer and that it is fresh.
Clean or replace the electrode.

Error 2 - Slope out of range

Make sure you have the correct buffer and that it is fresh.
Clean or replace the electrode.

Error 3 - Meter cannot recognize the buffer

Make sure you have the correct buffer and that it is fresh.
Check whether the buffer is used more than once in the calibration.

Error 4 - Data entry error in setting the user-defined buffer

When entering the user-defined buffer value, the meter doesn't accept a value whose pH differs by less than 1 pH unit from other pre-set values. Re-enter a value.

Error 5 - ATC measured temperature is different from the user-defined value.

Keep the buffer or sample at the set temperature or change the temperature setting.

Error 6 - the measured buffer temperature is out of the range (5... 50°C)

Keep the buffer temperature within the range.

Error 7, (----) - mV value out of range

Make sure the electrode is connected.
If no electrode is connected, place the shorting clip in the socket.

Error 8 - pH measuring value out of range

Check if the electrode wetting cap is removed and if the electrode is properly connected and placed in a sample solution.

Error 9 - Self-diagnosis failed

Repeat self-diagnosis process and make sure that you press the correct keys while the  icon is blinking. If Err 9 still appears, call QiS service.

10. Maintenance

10.1 Meter maintenance

There are no user-replaceable parts in the meter or power supply unit. Do not remove the covers. The ProLine needs no maintenance except for an occasional wipe with a damp cloth. The housing is made of ABS/PC which is attacked by some organic solvents, such as toluene, xylene and methyl ethyl ketone. It is good laboratory practice to wipe away any spillage immediately.

10.2 Electrode maintenance

Make sure the electrode is always kept filled with the appropriate filling solution. For maximum accuracy, any filling solution that may have "crept" and encrusted the outside of the electrode should be removed with distilled water.

Always store the electrode properly and do not allow it to dry out.

If the electrode slope value falls rapidly, or if the response becomes sluggish or inaccurate, the following procedures may help. Try them one by one in the order given.

1. Degrease the membrane with cotton wool soaked in either acetone or soap solution.
2. Soak the tip of the electrode in 0.1 M HCl overnight.
3. If a protein build-up has occurred, remove deposits by soaking electrode in a HCl/pepsin solution (Order Nr. QS941X).
4. If a silver sulfide contamination has occurred, remove deposits by soaking electrode in a thiourea solution (Order Nr. QS901X).

Note

Cleaning and filling solutions should be handled with the same care given to toxic or corrosive substances.

10.3 Disposal



In conformance with the European Directive 2002/96/ EC on Waste Electrical and Electronic Equipment (WEEE) this device may not be disposed of in domestic waste. This also applies to countries outside the EU, per their specific requirements.

Please dispose of this product in accordance with local regulations at the collecting point specified for electrical and electronic equipment.

If you have any questions, please contact the responsible authority or the distributor from which you purchased this device.

Should this device be passed on to other parties (for private or professional use), the content of this regulation must also be related.

Thank you for your contribution to environmental protection.

11.**Accessories**

	Order no.
Power supply EU	QA8550X
Power supply UK	QA8560X
Power supply US	QA8570X
Swing arm electrode holder	QA854X
Printer	QA8060X
Printer paper, pk/5	QA8070X
Printer cable	QA8080X
pH buffer 4 (red), 500ml	QS910X
pH buffer 7 (yellow), 500ml	QS912X
pH buffer 9 (green), 500ml	QS914X
pH buffer 10 (blue), 500ml	QS916X
pH storage solution 3M KCl, 500ml	QS942X
pH Filling solution 3M KCl, 500ml	QS937X
pH Filling solution 3M KCl/ AgCl, 100ml	QS938X
pH electrode; temperature sensor; gel-filled, epoxy	QP2111T
pH electrode; temperature sensor; refillable, glass	QP2104T

12. Specifications

	pH	mV	Temperature
Measurement Range	0.00 - 14.00	± 1999	-5 ... 105 °C
Resolution	0.01	1	0.1 °C
Relative Accuracy	± 0.01	± 1	± 0.5 °C
pH-calibration	1, 2, or 3 points		
Isopotential Point	7.00 pH		
Calibration Buffer	B1: (25 °C)	7.00	4.00 10.01 1.68
	B2: (25 °C)	7.00	4.01 9.21 2.00 11.00
	B3: (20 °C)	7.00	4.00 9.00 2.00 12.00
	B4: (25 °C)	6.86	4.01 9.18 1.68
	B5: User-defined		
Temperature Compensation	-5 ... 105 °C automatic or manual		
Display	Liquid crystal		
Outputs	RS232 serial, Baud rate: 1200 Data bit: 8 Stop bit: 1 Parity: none		
pH input	Impedance > 10 ¹² Ohm		
Ambient Conditions	Ambient temperature: 5 °C ... 40 °C Relative humidity: 5 % ... 80 % (non condensing) Installation category: II Pollution degree: 2		
Size/Weight	180 x 180 x 65 mm / 0.61 kg		
Materials	Housing: ABS, PC enforced Electrode stand: ABS, PC enforced Membrane keypad: Polyester		
Power Requirements	The ProLine pH meter is supplied with an appropriate power supply unit: - USA: 120 V / 60 Hz, 10 VA, 9 V DC - Europe: 230 V / 50 Hz, 10 VA, 9 V DC - UK: 240 V / 50 Hz, 10 VA, 9 V DC - Japan: 110 V / 50 Hz, 10 VA, 9 V DC - Australia: 240 V / 50 Hz, 10 VA, 9 V DC - China: 220 V / 50 Hz, 10 VA, 9 V DC - Battery (optional): 4 x AA (LR6)		

Note

The ProLine pH meter should only be used with the power supply unit supplied, or with batteries.

13. Quick Guide

1. Prepare Electrode



Remove cap

2. 1-Point Calibration

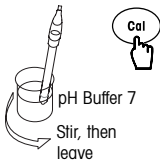

pH Buffer 7
Stir, then leave

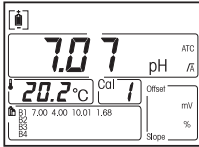

auto endpoint or

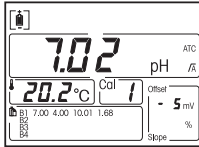

3. Rinse Electrode

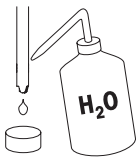

4. 2 or 3-Point Calibration



Repeat step 2 when carrying out a 2 or 3-point calibration, then rinse

5. Measure sample



Sample
Stir, then leave

auto endpoint or

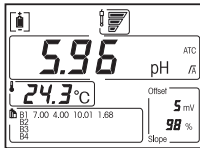

6. Rinse Electrode

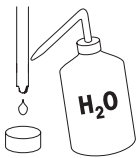

7. Store Electrode

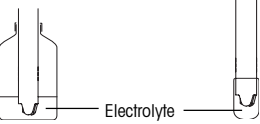

Electrolyte

14. Buffer sets

ProLine pH Meter automatically corrects for setting temperature using the values shown in the tables:

Buffer Set 1 (ref. 25 °C)

5	7.09	4.00	10.25	1.67
10	7.06	4.00	10.18	1.67
15	7.04	4.00	10.12	1.67
20	7.02	4.00	10.06	1.68
25	7.00	4.00	10.01	1.68
30	6.99	4.01	9.97	1.68
35	6.98	4.02	9.93	1.69
40	6.97	4.03	9.89	1.69
45	6.97	4.04	9.86	1.70
50	6.97	4.06	9.83	1.71

Buffer Set 2 (ref. 25 °C)

5	7.09	4.01	9.45	2.02	11.72
10	7.06	4.00	9.38	2.01	11.54
15	7.04	4.00	9.32	2.00	11.36
20	7.02	4.00	9.26	2.00	11.18
25	7.00	4.01	9.21	2.00	11.00
30	6.99	4.01	9.16	1.99	10.82
35	6.98	4.02	9.11	1.99	10.64
40	6.97	4.03	9.06	1.98	10.46
45	6.97	4.04	9.03	1.98	10.28
50	6.97	4.06	8.99	1.98	10.10

Buffer Set 3 (ref. 20 °C)

5	7.07	4.04	9.16	2.01	12.41
10	7.05	4.02	9.11	2.01	12.26
15	7.02	4.01	9.05	2.00	12.10
20	7.00	4.00	9.00	2.00	12.00
25	6.98	4.01	8.95	2.00	11.88
30	6.98	4.01	8.91	2.00	11.72
35	6.96	4.01	8.88	2.00	11.67
40	6.95	4.01	8.85	2.00	11.54
45	6.95	4.01	8.82	2.00	11.44
50	6.95	4.00	8.79	2.00	11.33

Buffer Set 4 (ref. 25 °C)

5	6.95	4.00	9.40	1.67
10	6.92	4.00	9.33	1.67
15	6.90	4.00	9.28	1.67
20	6.88	4.00	9.22	1.68
25	6.86	4.01	9.18	1.68
30	6.85	4.02	9.14	1.68
35	6.84	4.02	9.10	1.69
40	6.84	4.04	9.07	1.69
45	6.83	4.05	9.04	1.70
50	6.83	4.06	9.01	1.71



Quality certificate. Development, production and testing according to ISO9001.
Environmental management system according to ISO14001.



Worldwide service. Our extensive service network is among the best in the world and ensures maximum availability and service life of your product.



European conformity. The CE conformity mark provides you with the assurance that our products comply with the most recent EU directives.



On the Internet. You will quickly find lots of essential information about our products, our services, and our company at
<http://www.q-i-s.net>



Bredaseweg 108a
4902 NS Oosterhout, NL
PO Box 173
4900 AD Oosterhout, NL
T. +31 (0)162 47 14 85
F. +31 (0)162 47 14 86
info@q-i-s.net
www.q-i-s.net

Subject to technical changes and to the availability
of the accessories supplied with the instruments.
Version 2007-01