Operating Instructions



SenseLine Plus
Dissolved oxygen meter F450



Contents

1.	Introduction	3
2.	Safety measures	3
3.	Installation	5
3.1	Installing the batteries	5
3.2	Fitting the wrist strap	5
4.	Operating the F450 dissolved oxygen meter	6
4.1	The display	6
4.2	Key controls	7
4.3	Operation with softkeys	8
4.4	Calibration	8
4.5	Sample measurement	9
4.5.1	Oxygen concentration in mg/L or ppm range	9
4.5.2	Oxygen saturation measurement	9
4.6	Menus for dissolved oxygen measurement	10
4.7	Handling your stored data	14
4.7.1	Menu structure	14
4.7.2	Infrared interface	14
4.8	Working with routine mode	15
4.9	Error messages	15
5.	Maintenance	16
5.1	Meter maintenance	16
5.2	Electrode maintenance	16
5.3	Disposal	16
6.	Accessories	17
7.	Specifications	18
8.	Appendix	19
8.1	Error Limits	19
8.2	Algorithm for O ₂ concentration measurement	19
8.3	Solubility of oxygen in water as a function of temperature and salinity	20

1. Introduction

Thank you for purchasing this high quality QiS portable meter. SenseLine is much more than just a series of portable meters with an excellent price/performance ratio. It is an ingenious concept that includes many exciting new features:

- IP67 rating: this applies to the instrument itself as well as to the sensors and the connections;
- optimum ease of use, making the operating instructions primarily a source of reference;
- excellent Ergonomics, as if the instrument were part of you;
- option for regular equipment qualification, giving you full confidence that your measurement results are always accurate;

2. Safety measures

Measures for your protection



- Never work in an environment subject to explosion hazards! The housing of the instrument is not gas tight (explosion hazard due to spark formation, corrosion caused by the ingress of gases).



- When using chemicals and solvents, comply with the instructions of the producer and the general lab safety rules!

Measures for your operational safety



- Do not unscrew the two halves of the housing.
- Have the instrument serviced only by QiS Service!
- Dry off any liquids sprayed immediately! The instrument is not watertight.
- Exclude the following environmental influences:
 - powerful vibrations,
 - direct sunlight,
 - atmospheric humidity greater than 80%,
 - corrosive gas atmosphere,
 - temperatures below 5 °C and above 40 °C,
 - powerful electric or magnetic fields!

Installation

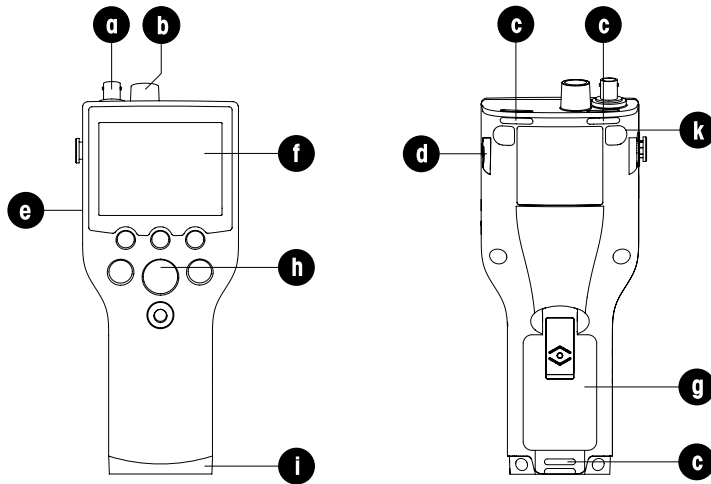

a BNC socket for signal input

b Cinch socket for temperature signal input

c Slots for attaching the wrist strap

d Fixing points

e Infrared (IrDA) window

f Display

g Battery cover

h Rubber key pad

i Bottom cap

k Rubber feet fixing points

3. Installation

Carefully unpack the meter. Keep the calibration certificate in a safe place.

3.1 Installing the batteries

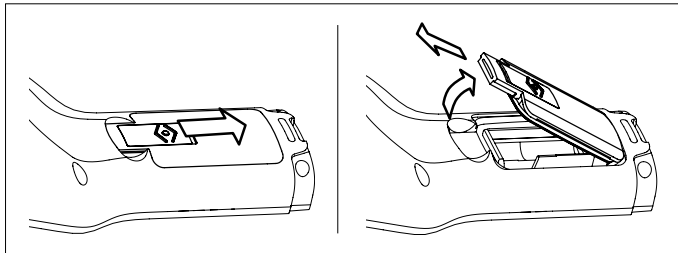

1. Push the button on the Battery cover in the direction of the arrow, hold the lid with two fingers and remove it, as shown;
2. Insert the batteries in the battery compartment;
3. Replace the Battery cover, and push back the button to fix the lid in place.

Note

The IP67 rating requires the battery compartment to be perfectly sealed. The sealing ring around the Battery cover must be replaced if it is damaged in any way (SenseLine Sealing Kit, QA8110X).

3.2 Fitting the wrist strap

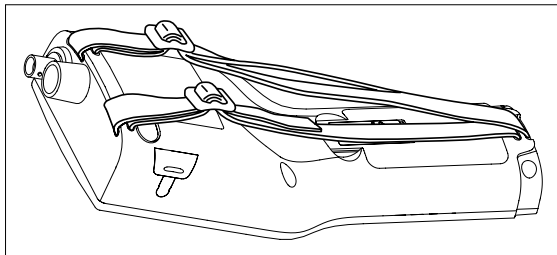



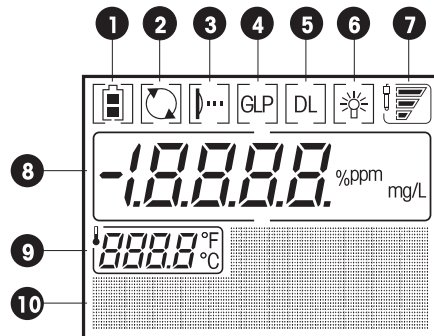

Fit the wrist strap as shown in the diagram.

4. Operating the F450 dissolved oxygen meter

4.1 The display







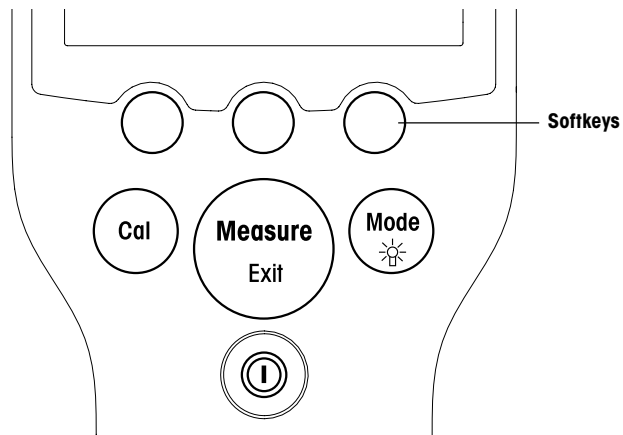

- 1 Battery status shows the condition of the batteries, fully charged, half-charged or fully discharged.
(To replace batteries see Section 3.1)
- 2 Auto-off override, in default operation, the meter switches itself off after 15 minutes to prolong battery life. After switching off/on the auto-off is active again
- 3 IrDA infrared interface for data transfer to printer or PC (See Section 4.7)
- 4 GLP print-out is activated (See end of Section 4.6)
- 5 Data Logging, timed interval reading is active, data is transferred to memory at a user-defined interval
- 6 Backlighting, meter switches on backlighting when any key is pressed
- 7 Electrode condition (for electrode maintenance, see section 5.2)

		
Slope: 80-125% Electrode is in good condition	Slope: 70-79% Electrode needs cleaning	Slope: 60-69% Electrode needs replacing of membrane or the electrolyte
-  The frame blinks when the calibration reminder is on and a calibration is due.
- 8 Dissolved oxygen reading
- 9 Temperature
- 10 Dot matrix area

4.2 Key controls



	Press and release 	Press and hold for 2 seconds 
	- Meter on/off	- Switch on/off auto-off override (switches off the meter after 15 minutes)
	- Start or endpoint measurement - Back to measurement mode (ignore the input)	
	- Start calibration	
	- Switch between saturation, ppm and mg/L	- Backlighting: on/off (when backlighting is on, the meter switches on backlighting at the stroke of any key for a user defined period of 10, 15 or 30 seconds.)

4.3 Operation with softkeys

The F450 dissolved oxygen meter has three softkeys. The functions assigned to them change during operation depending on the application. The assignment is shown on the bottom line of the screen.

Example: In the a measurement screen, the three softkeys are assigned as follows:

Menu	Store	Data
Activate menu setting	Store an endpoint measurement	Activate "Data" menu

The other soft key functions are as follows:

→	Move one digit to the right	+	Increase value by one
Enter	Enter the highlighted menu Accept the entered value	Exit	One level up in the menu tree
Select	Select the highlighted function	↓	Scroll through the menu
Edit	Change the settings	End	Store and quit menu
Save	Save the calibration data	Trans	Transfer data to printer or PC
Delete	Delete the selected data	Yes	Confirm deletion

4.4 Calibration

Preparing for calibration

- Before performing a calibration, the sensor has to be connected to the instrument for at least 6 hours (polarization time).
- Before performing a calibration, the membrane must be examined for damage or contamination. If the membrane is dirty, clean carefully with a soft, moist cloth.

Performing a 1-Point calibration

- For calibration in vapor-saturated air (100% O₂) place the electrode in a bottle 1 cm above the water surface as shown in the graphic below.

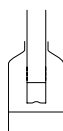

- Press then **Cal**. The meter endpoints according to the pre-selected endpoint settings after the signal has stabilized or after pressing **Measure**.
- Terminate calibration by pressing the **End** softkey. After the reading has endpointed, calibration results appear in the display.
- To use the calibration data for later measurements, press **Save**.
- To discard the calibration data, press **Cancel**.

Performing a 2-Point calibration

- Perform the first point calibration as described under "1-Point calibration".
- Place the DO sensor in the zero oxygen standard (QA802X) and press **Cal**. The meter endpoints according to the pre-selected endpoint settings after the signal has stabilized or after pressing **Measure**.
- End calibration by pressing the **End** softkey. After the reading has endpointed, the calibration results appear in the display.
- To use the calibration data for later measurements, press **Save**.
- To discard the calibration data, press **Cancel**.

Note

- To ensure the most accurate dissolved oxygen readings, it is advisable to calibrate regularly.
- For the 1point-calibration, the sensor must be removed from the medium, gently cleaned and dried. Water droplets on the membrane must be removed because they prevent the sensor from being correctly calibrated.
- Zero point calibrations are frequently a source of error. Due to the very low zero current of QiS sensors, zero point calibration is unnecessary even for measurement at low oxygen concentrations.

4.5 Sample measurement**4.5.1 Oxygen concentration in mg/L or ppm range**

Place the DO sensor in the sample and press **Measure** to start the measurement: the decimal point blinks. The display shows the oxygen concentration of the sample in mg/L. The automatic endpoint **A** is the meter's default setting. When the sensor output has stabilized, the display automatically freezes, and \sqrt{A} appears.

Select automatic, manual or timed end-pointing method in the menu under "2. Set meas." in "1. EP Format".

To manually endpoint a measurement press **Measure**, the display freezes and \sqrt{m} appears.

If the timed endpointing method is selected, the display freezes automatically after the set time has elapsed and \sqrt{f} appears.

Note

For stability criterion of automatic endpoint algorithm (**A**) see Section 4.6.

4.5.2 Oxygen saturation measurement

To perform an oxygen saturation measurement in %, follow the same procedure as for an oxygen concentration in mg/L or ppm measurement. Press **Mode** to switch between oxygen concentration in mg/L, ppm and oxygen saturation measurement modes.

4.6 Menus for dissolved oxygen measurement

The Senseline Plus F450 dissolved oxygen meter allows you to perform four different types of measurement: ppm, mg/L, and %. To switch to the measurement mode you require, press **Mode**.

Menu structure

ppm – mg/L – %

1. Set temp.

1. MTC temp.
2. Temp. unit
 1. °C
 2. °F

2. Set meas.

1. EP format
 1. Auto
 2. Manual
 3. Timed
2. Sal. comp.
3. Bar. comp.
 1. Auto
 2. Manual
4. Bar. unit
 1. mbar
 2. hPa
 3. Torr
 4. Atm

3. Sensor ID

4. Cal. Remind

5. Data log

1. Auto save
 1. Off
 2. On
2. T- int. read
 1. Off
 2. On

6. Data output

1. To printer
2. To Bal. Link

7. GLP

1. GLP
2. Non-GLP

8. System

1. Time
2. Date
3. Light off
4. Selftest

Set temp.**Set MTC temperature**

If the meter does not detect a temperature probe, it automatically switches to the manual temperature compensation mode and MTC appears. In this case the temperature of the sample has to be entered in the Set MTC menu (0 °C...60 °C). The meter calculates the temperature-adjusted electrode slope using this temperature and shows the temperature-compensated value in the measurement display.

Note

For better accuracy, we recommend the use of either a built-in or a separate temperature probe. If a temperature probe is used, the ATC symbol and the sample temperature are displayed.

Set meas.**EP format**

With this menu you can choose between one of three different types of endpoint formats:

"Auto"

Automatic endpoint \overline{A} is a special algorithm that determines the end of an individual reading, depending on the behavior of the sensor used.

Stability criterion for dissolved oxygen measurements

The meter will endpoint if the signal changes less than 0.052 nA in 30 seconds.

"Manual"

Manual endpoint \overline{M} means the meter never endpoints the reading unless the user manually presses the **Measure** key.

"Timed"

With the timed endpoint \overline{T} , the reading is ended automatically when the set time period has elapsed.

Note

Every measurement can be endpointed manually by pressing the **Measure** key. The meter then displays \overline{M} .

The table below shows how the endpoint format is displayed in the course of the measurement.

Preselected format	Start of measurement	Signal stability	Endpointed measurement ¹⁾
Auto endpoint	A	\overline{A}	\overline{A}
	A	Measure \Rightarrow	\overline{M}
Manual endpoint	M	\overline{M} Measure \Rightarrow	\overline{M}
	M	Measure \Rightarrow	\overline{M}
Timed endpoint	T	\overline{T} \Rightarrow	\overline{T}
	T	Measure \Rightarrow	\overline{M}

¹⁾ The actual endpoint format (last column) not the preselected is stored with the data.

Menus

"Sal. comp." (Salinity compensation)

A salinity correction is required in the oxygen concentration measurement of samples with a salt content of more than 1 ppt. The meter does the correction automatically after you have entered the ion concentration in this menu (salinity range from 0.0 to 70.0 ppt $\hat{=}$ 70 g/L).

"Bar. comp." (Barometric compensation)

A barometric compensation is required in the oxygen concentration measurement and calibration.

Auto: The F450 meter can automatically determine the current pressure by means of a integrated pressure sensor.

Manual: User can enter the absolute ambient atmospheric pressure.

"Bar. unit" (Barometric unit)

There are four barometric units available for barometric reading:

mbar, hPa, Torr and Atm.

Every unit can be calculated from the standard unit Pa using the following formulas:

mbar = hPa = 100 Pa

Torr = 133.322 Pa

Atm = 101325 Pa

Sensor ID

You can set an 8-digit, numerical sensor ID. In the GLP mode, the sensor ID will be assigned to each calibration and measurement value. This allows you to trace back data.

Cal Remind

If you choose calibration reminder "ON", you are reminded to perform a new calibration after a certain user defined interval (maximum 9999 h) has elapsed. In this case \uparrow blinks.

Data log

The F450 is designed to store up to 200 sets of measurement data in the memory.

Auto Save

"Auto Save" logs automatically every end-pointed reading \bar{A} , \bar{M} & \bar{T} to the memory.

If "Auto Save" is set to **Off**, the **Store** softkey appears in the measuring screen. You can then manually store endpointed data by pressing this softkey.

T-int. read (Timed-interval reading)

With timed-interval reading, a reading is stored to memory every time after a certain interval (3 – 9999 s) defined in the menu has passed. You may stop the reading by pressing **Measure**. When timed-interval reading is "on", DL is shown on the display.

For readings lasting longer than 15 minutes, switch off the auto-off function by pressing and holding down Ⓢ for two seconds.

When working in the timed-interval reading mode, you can define the length of the measurement period by selecting the appropriate endpoint mode (\bar{A} , \bar{M} and \bar{T}) in the menu "2. Set meas." under the item "1. EP format".

Data output

Data stored in the instrument's memory can be transferred to the QiS printer or PC through the infrared interface.

GLP

You can choose between two different data formats when outputting the data from memory: GLP ON or GLP OFF:

Examples**GLP format**

GLP	On
Date	01-JAN-07 / JAN-01-07
Time	09:31:03
Sample_ID	000326
Result	8.26 mg/L
Temperature	25.3 °C
Pressure	1015 mbar
ATC/MTC	ATC
Endpoint	Auto
Sensor_ID	04102601
Last_cal.	10-26-06
Signature	-----

Non-GLP format

GLP	Off
Result	8.26 mg/L
Temperature	25.3 °C
Pressure	1015 mbar
ATC/MTC	ATC
Endpoint	Auto

System**"Light off"**

You can define the period (10 s, 15 s, 30 s) after which the back lighting switches off automatically.

Note

The light function can be turned on/off by just pressing and holding the  button.

"Self test"

This menu item starts the self diagnosis routine. The meter displays the full screen first, then each icon blinks one after the other. This way you may check whether all icons are shown regularly. The final step is to check that the keys are functioning correctly. This requires user interaction.

You are now requested to press the seven function keys on the keypad one by one in any order: after pressing a key, an icon disappears from the display; continue to press the other keys until all the icons have disappeared.

When self diagnosis has been terminated successfully the meter returns to the system menu. If errors are reported contact QIS Service

Note

You have to finish pressing all the seven keys within two minutes, otherwise "Self test failed!" appears, and you will have to repeat the procedure.

4.7 Handling your stored data

4.7.1 Menu structure

To access the memory, press the **Data** softkey.

1.	Meas. Data	(Enter measurement database)
1.	Review	(Review data)
2.	Transfer	(Transfer data)
1.	Partial	(Set parameter to transfer part of data from memory)
2.	All	(Transfer all data from memory)
3.	Delete	(Delete data)
1.	Partial	(Set parameter to delete part of data from memory)
2.	All	(Delete all data from memory)
2.	Cal. Data	(Enter calibration database)
1.	Current	(Review/transfer current calibration data)
2.	5 latest	(Review/transfer 5 latest calibration data)

4.7.2 Infrared interface

With Senseline Plus it is possible to transfer either all data or a user defined series of data from the memory to a QiS printer or to a PC. The data transfer goes via the IR interface on the left side of the meter.

The following descriptions show how to proceed with the different configurations:

- Data transfer from Senseline Plus to a printer is done using an IR-RS232 adapter (QA8580X). To prepare for data transfer connect the RS232 plug to the corresponding interface on the backside of the printer and point the instrument's IR window to the IR receiver on the other end of the adapter cable. Start data transfer in the data menu.
- For data transfer from Senseline Plus to a PC two different ways are possible:
 - direct transfer via an IrDA interface on your PC
 - transfer via IR-RS232 adapter (QA8580X)

Open Hyper Terminal or BalanceLink. Adjust the settings for data transfer as follows:

Baud rate: 1200 IR-USB / 9600 IR-RS232
Data bits: 8
Parity: none
Stop bits: 1
Handshake: none

Connect the adapter to the PC and/or point the IR window of the meter to the receiver. Start the data transfer by selecting the transfer item in the data menu.

4.8 Working with routine mode

The Senseline Plus meter has two working modes:

Expert mode	The default setting enables all functions of the meter
Routine mode	All system and calibration settings are fixed according to what was defined in the expert mode.

In the routine mode the meter only allows the following functions:

- Calibrating and measuring
- Editing the MTC temperature
- Storing, viewing and printing data

Activation of the routine mode

To change to the routine mode, switch off the meter. Press **Measure, Mode** and the **right** softkey simultaneously. The meter now allows you to select the working mode.

Select "1. Routine" and confirm by pressing **Select**. The meter switches itself off automatically. Switch on the meter by pressing **On/Off**. From now on you can work safely without the risk of unintentionally changing settings or deleting data.

Activation of expert mode

To enable all functions, switch off the meter and press **Measure, Mode** and the **right** softkey simultaneously.

Select "2. Expert" and confirm by pressing **Select**. The meter switches itself off automatically. Switch on the meter by pressing **On/Off**. You now have access to all menu functions again.

Note

The concept of the two working modes is a GLP feature that ensures that important settings or stored data cannot be unintentionally changed under routine working conditions.

4.9 Error messages

Self test failed!		Repeat the self-diagnosis procedure and make sure that you finish pressing all seven keys within two minutes. If "Self test failed!" still appears, call QiS Service.
Meas. out of range!	Measured value out of range	Check if the DO sensor is properly connected and placed in a sample solution. Check if the wetting cap has been removed.
Full!	Data memory is full	Go to "Data" to delete data, otherwise you will not be able to store new measurement data.
Invalid value!	The value you entered is invalid	Reenter a value.
Cal.1 out of range!		Clean the sensor tip and replace electrolyte. Check the membrane for damage, replace as necessary.
Cal.2 out of range!		Check if fresh zero oxygen solution is used. Clean the sensor tip and replace electrolyte. Check the membrane for damage, replace as necessary.

5. Maintenance

5.1 Meter maintenance

Never unscrew the two halves of the housing.

The SenseLine series instruments do not require any maintenance other than an occasional wipe with a damp cloth and the replacement of used-up batteries.

The housing is made of acrylonitrile butadiene styrene/polycarbonate (ABS/PC). This material is attacked by some organic solvents, such as toluene, xylene and methyl ethyl ketone (MEK). Any spillage should be wiped off immediately.

5.2 Electrode maintenance

When used in water applications, the sensor is designed to require minimal service. However in some case it can be necessary to recalibrate the sensor or to change the electrolyte or the membrane.

5.3 Disposal



In conformance with the European Directive 2002/96/ EC on Waste Electrical and Electronic Equipment (WEEE) this device may not be disposed of in domestic waste. This also applies to countries outside the EU, per their specific requirements.

Please dispose of this product in accordance with local regulations at the collecting point specified for electrical and electronic equipment.

If you have any questions, please contact the responsible authority or the distributor from which you purchased this device.

Should this device be passed on to other parties (for private or professional use), the content of this regulation must also be related.

Thank you for your contribution to environmental protection.

6. Accessories

	Order no.
SenseLine pH meter F410	
SenseLine Conductivity meter F430	
SenseLine Plus Ion/pH meter F470	
Swing arm electrode holder	QA854X
Sealing kit	QA8110X
AA batteries, pk/4	QA8120X
Carrying case	QA8130X
Printer	QA8140X
Printer paper, pk/5	QA8150X
RS232 infrared adapter	QA8580X
Spare membranes (set 3)	QA1800X
BOD adapter	QA803X
Oxygen electrolyte, 100ml	QA1804X
Zero solution, 100ml	QA802X
Dissolved oxygen electrode; temperature sensor, PPS, 1m cable, IP67	QD2400T
Dissolved oxygen electrode; temperature sensor, PPS, 10m cable, IP67	QD2400T10

7. Specifications

Senseline Plus dissolved oxygen meter F450	
Measurement range	DO 0.00...99.00 mg/L 0.00...99.00 ppm 0.0%...600.0%
	Pressure 500...1100 mbar
	Temperature 0...60 °C
Resolution	DO 0.01 mg/L 0.01 ppm 0.1%
	Pressure 1 mbar
	Temperature 0.1 °C
Limits of error	DO ±0.5% of measured value
	Pressure ±1% (15 °...35 °)
	Temperature ±0.1 °C
Output	IrDA
Power requirements	Ratings 6 V DC, 70 mA
	Batteries 4 x AA/LR6, 1.5 V DC or 4 x AA/LR6 NiMH, 1.2 V DC rechargeable
Size/Weight	220 x 90 x 45 mm / 0.33 kg
Display	Liquid crystal
Signal input	BNC (IP67), Impedance >10 ¹² Ω
T input	Cinch (IP67), NTC 22 KΩ
IP rating	IP67 with and without electrode
Battery life	> 500 working hours (with no back lighting)
Ambient conditions	Temperature 5...40 °C
	Relative humidity 5%...80% (non-condensing)
	Installation category II
	Pollution degree 2
Materials	Housing ABS/PC reinforced
	Window polymethylmethacrylate (PMMA)
	Keypad silicone rubber

8. Appendix

8.1 Error Limits

Message description	Range not accepted
Measured value out of range	[O ₂]: < 0.1% or > 600%
	[O ₂]: < 0.01 mg/L or > 99 mg/L
	[O ₂]: < 0.01 ppm or > 99 ppm
Cal. 1 out of range	I: < 40 nA or > 110 nA
Cal. 2 out of range	T: < 0 nA or > 2 nA

8.2 Algorithm for O₂ concentration measurement

The (reading in ppm or mg/L) is given by the following equation:

$$c = \frac{I - I_0 \cdot [c_s(p_n) - (\text{Sal} \cdot F(T))]}{S_L \cdot X_{O_2} \cdot (p_n - p_w)}$$

- I: converted sensor current during measurement
- I₀: sensor residual current (assumed to be zero)
- c: O₂ concentration (ppm or mg/L)
- c_s: O₂ solubility in water (mg/L) at p_n, see Section 8.3
- p_n: standard pressure (1013 mbar)
- p_w: water vapor pressure at calibration temperature (mbar)
- X_{O₂}: molar ratio of O₂ in calibration gas (in air equal to 0.2095)
- S_L: sensor slope (pA/mbar)
- Sal: salinity of measuring solution (g/kg)
- F(T): temperature dependant salinity correction factor, see Section 8.3.

To calculate the saturation [%], the term

$[c_s(p_n) - (\text{Sal} \cdot F(T))]$ is replaced by 100%

S_L the sensor slope is determined in the calibration using the following equation:

$$S_L = \frac{(I_{\text{cal}} - I_0)}{X_{O_2} \cdot [p_{\text{cal}} - (rH \cdot p_w)]}$$

Appendix

S_s :	sensor slope (pA/mbar)
I_{cal} :	converted sensor current during calibration
I_o :	sensor residual current (assumed to be zero)
X_{O_2} :	molar ratio of O_2 in calibration gas (in air equal to 0.2095)
p_{cal} :	pressure of calibration gas (air pressure, in mbar)
rH:	relative humidity of calibration gas (0.0...1.0)
p_w :	water vapor pressure at calibration temperature (mbar)

8.3 Solubility of oxygen in water as a function of temperature and salinity

according to EN 25 814 and UNESCO tables (partly extrapolated)

Temperature (°C)	O ₂ solubility (mg/L)	Salinity correction factor F(T) (mg/L)
0	14.62	0.0875
1	14.22	0.0843
2	13.83	0.0818
3	13.46	0.0789
4	13.11	0.0760
5	12.77	0.0739
6	12.45	0.0714
7	12.14	0.0693
8	11.84	0.0671
9	11.56	0.0650
10	11.29	0.0632
11	11.03	0.0614
12	10.78	0.0593
13	10.54	0.0582
14	10.31	0.0561
15	10.08	0.0545
16	9.87	0.0532
17	9.66	0.0514
18	9.47	0.0500
19	9.28	0.0489
20	9.09	0.0475
21	8.91	0.0464
22	8.74	0.0453
23	8.58	0.0443
24	8.42	0.0432
25	8.26	0.0421
26	8.11	0.0407
27	7.97	0.0400
28	7.83	0.0389
29	7.69	0.0382
30	7.56	0.0371

Temperature (°C)	O ₂ solubility (mg/L)	Salinity correction factor F(T) (mg/L)
31	7.43	0.0365
32	7.30	0.0353
33	7.18	0.0345
34	7.06	0.0339
35	6.95	0.0331
36	6.83	0.0323
37	6.72	0.0316
38	6.61	0.0309
39	6.51	0.0302
40	6.41	0.0296
41	6.32	0.0289
42	6.23	0.0283
43	6.14	0.0277
44	6.05	0.0272
45	5.96	0.0266
46	5.88	0.0261
47	5.79	0.0256
48	5.71	0.0251
49	5.63	0.0247
50	5.55	0.0242
51	5.47	0.0238
52	5.39	0.0234
53	5.31	0.0231
54	5.24	0.0228
55	5.16	0.0225
56	5.08	0.0222
57	5.00	0.0220
58	4.91	0.0218
59	4.83	0.0216
60	4.74	0.0215



Quality certificate. Development, production and testing according to ISO9001.
Environmental management system according to ISO14001.



Worldwide service. Our extensive service network is among the best in the world and ensures maximum availability and service life of your product.



European conformity. The CE conformity mark provides you with the assurance that our products comply with the most recent EU directives.



On the Internet. You will quickly find lots of essential information about our products, our services, and our company at <http://www.q-i-s.net>



**Bredaseweg 108a
4902 NS Oosterhout, NL
PO Box 173
4900 AD Oosterhout, NL
T. +31 (0)162 47 14 85
F. +31 (0)162 47 14 86
info@q-i-s.net
www.q-i-s.net**

Subject to technical changes and to the availability
of the accessories supplied with the instruments.
Version 2007-01